

Write names of each Picture

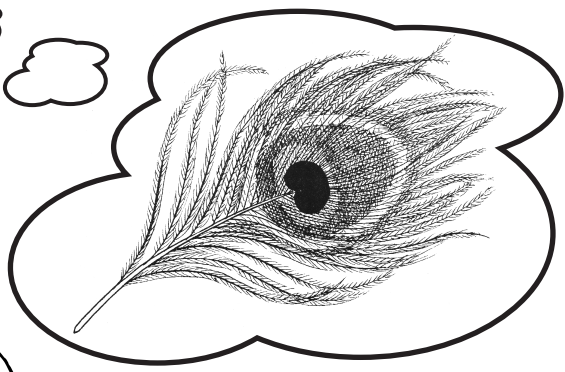

1 \_\_\_\_\_



2 \_\_\_\_\_

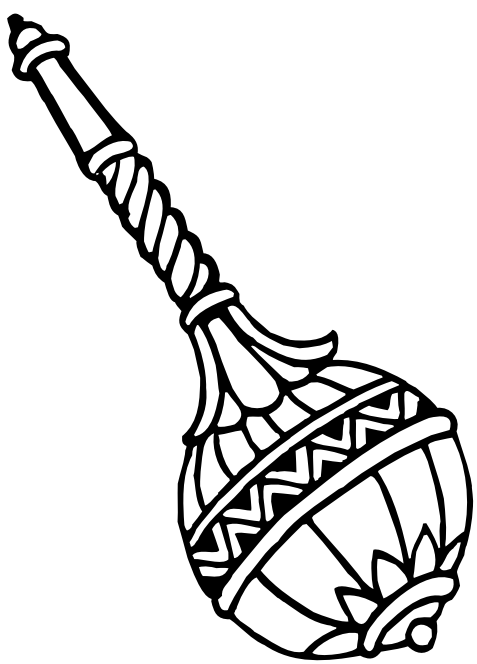

3 \_\_\_\_\_

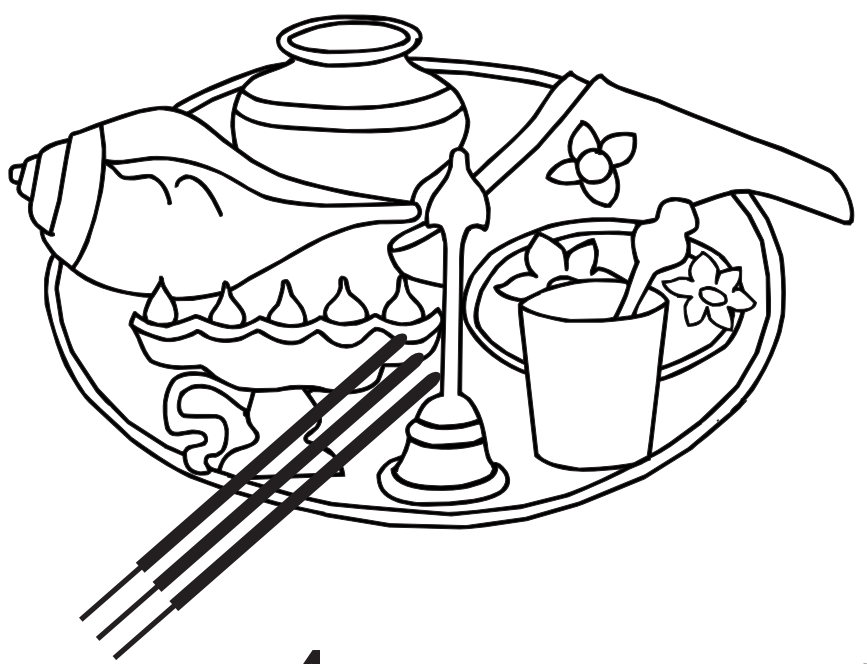

4 \_\_\_\_\_

--	--	--	--

1      2      3      4

Write first Alphabet of each No. Picture

Write names of each Picture

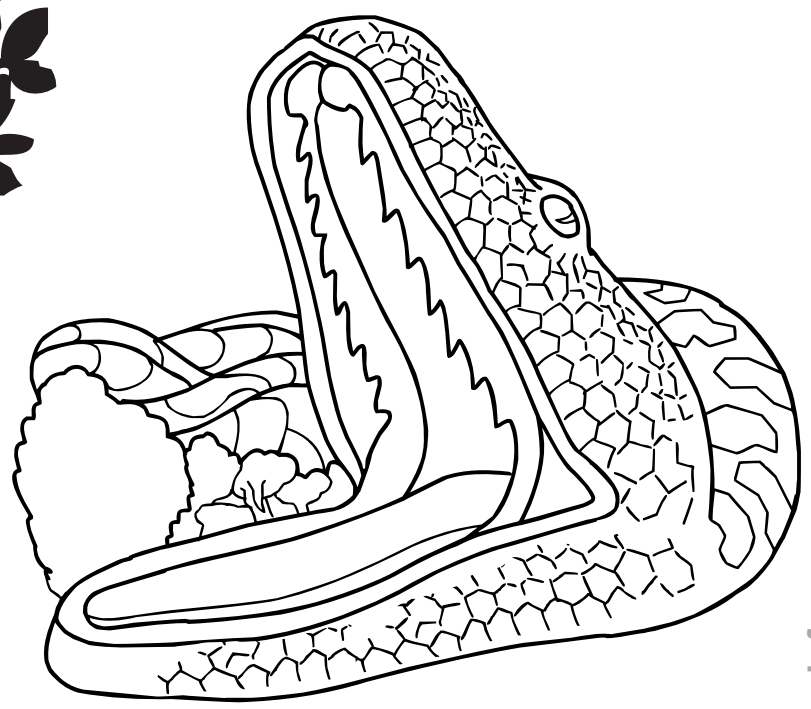
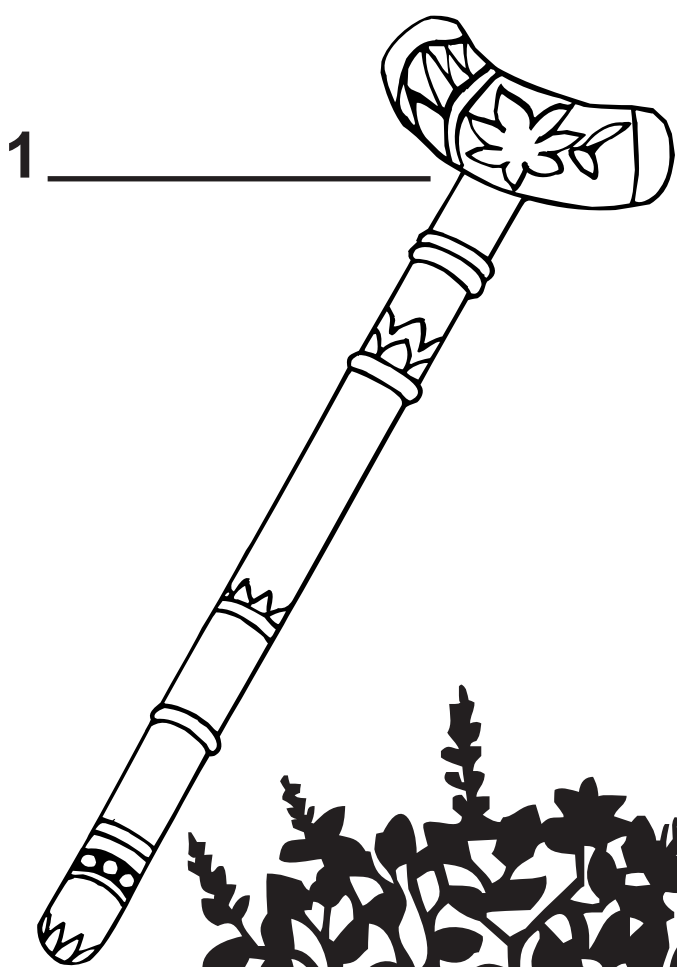

1	2	3	4

Write first Alphabet of each No. Picture

Write names of each Picture

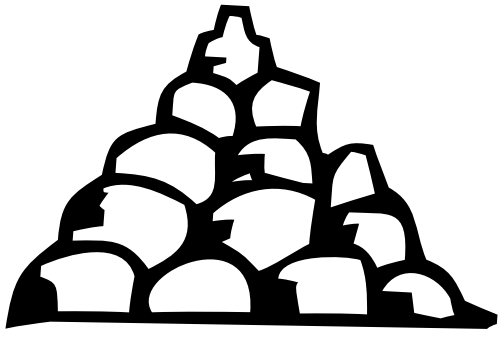

1 \_\_\_\_\_



2 \_\_\_\_\_

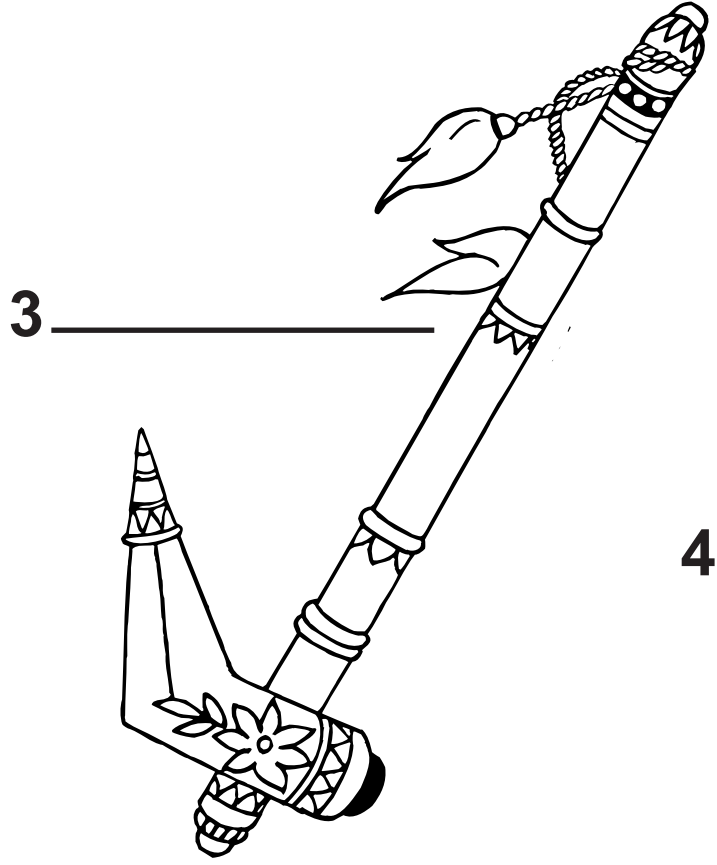

3 \_\_\_\_\_

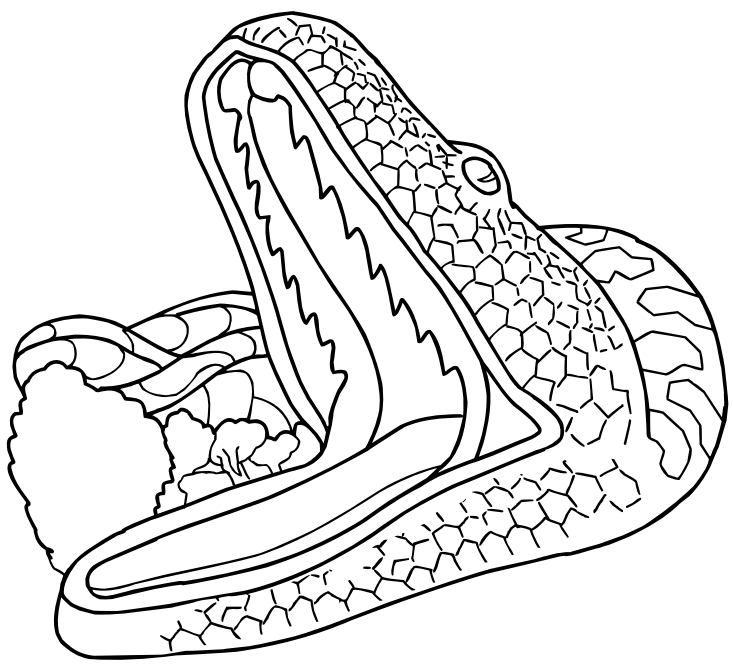

4 \_\_\_\_\_

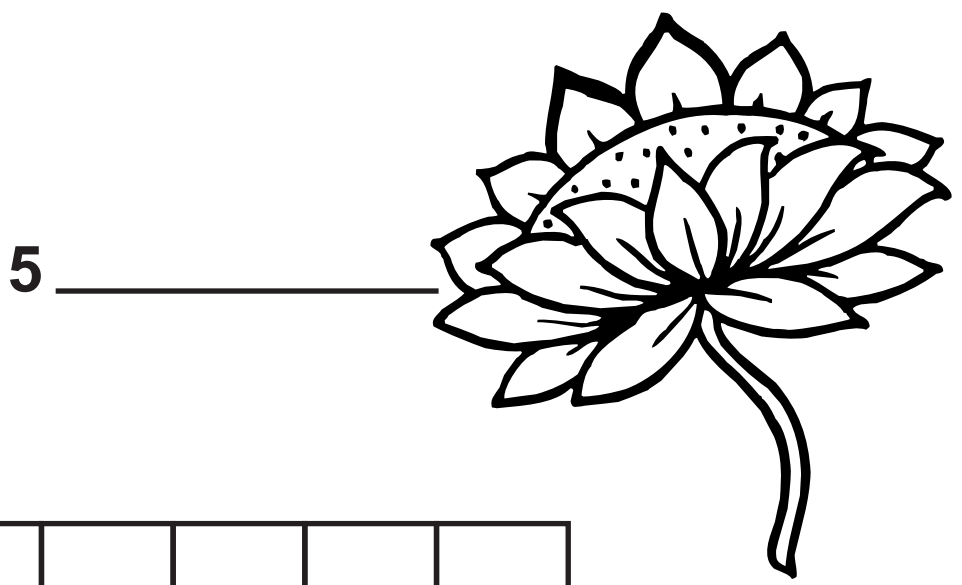

5 \_\_\_\_\_

--	--	--	--	--

1      2      3      4      5

Write first Alphabet of each No. Picture

Write names of each Picture

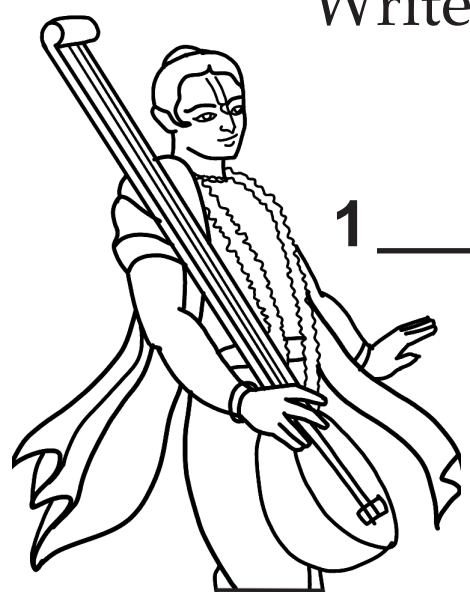

1 \_\_\_\_\_



2 \_\_\_\_\_

3 \_\_\_\_\_

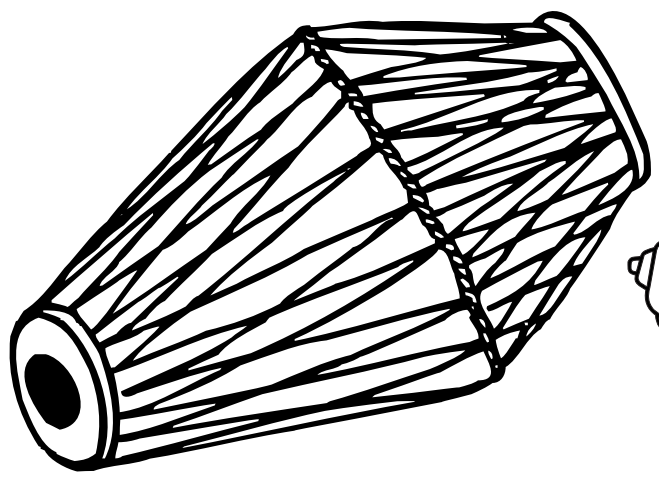

4 \_\_\_\_\_

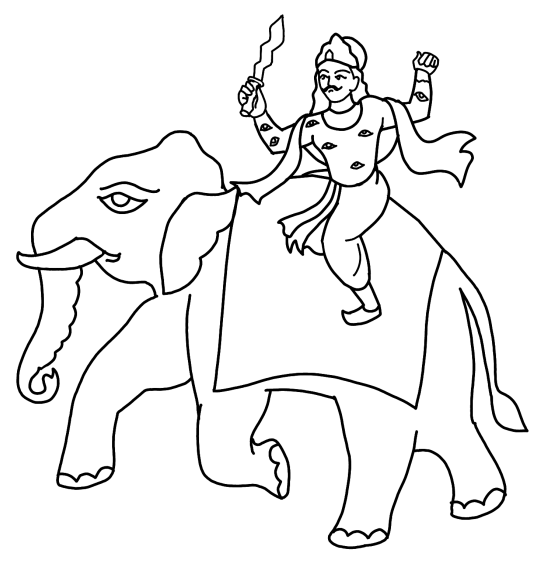

5 \_\_\_\_\_

--	--	--	--	--

1      2      3      4      5

Write first Alphabet of each No. Picture

Write names of each Picture

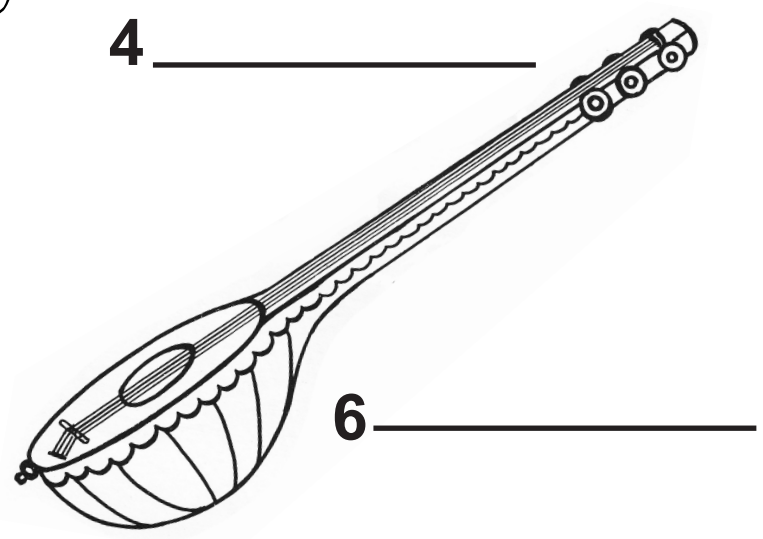
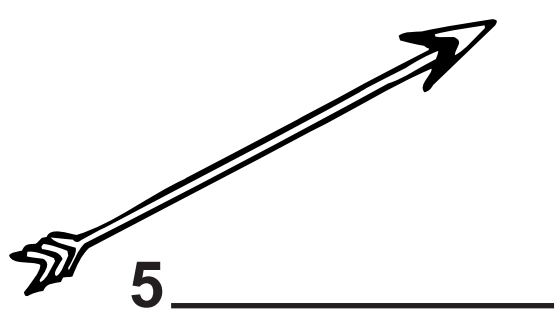
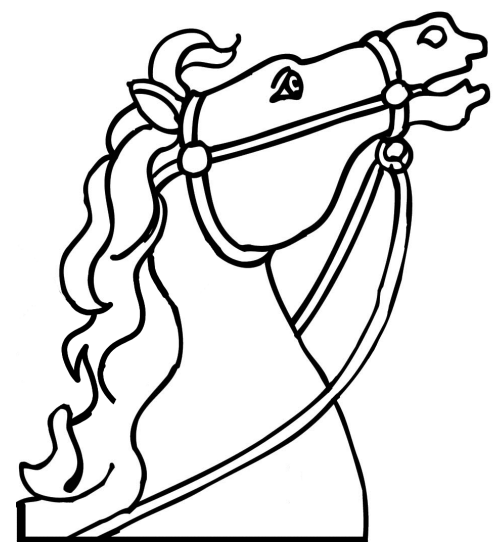
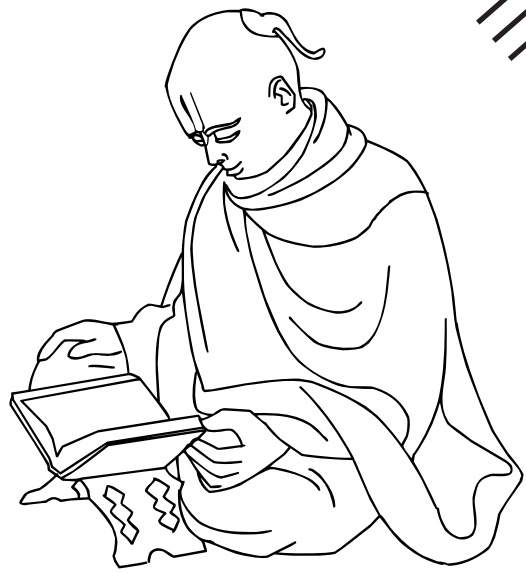
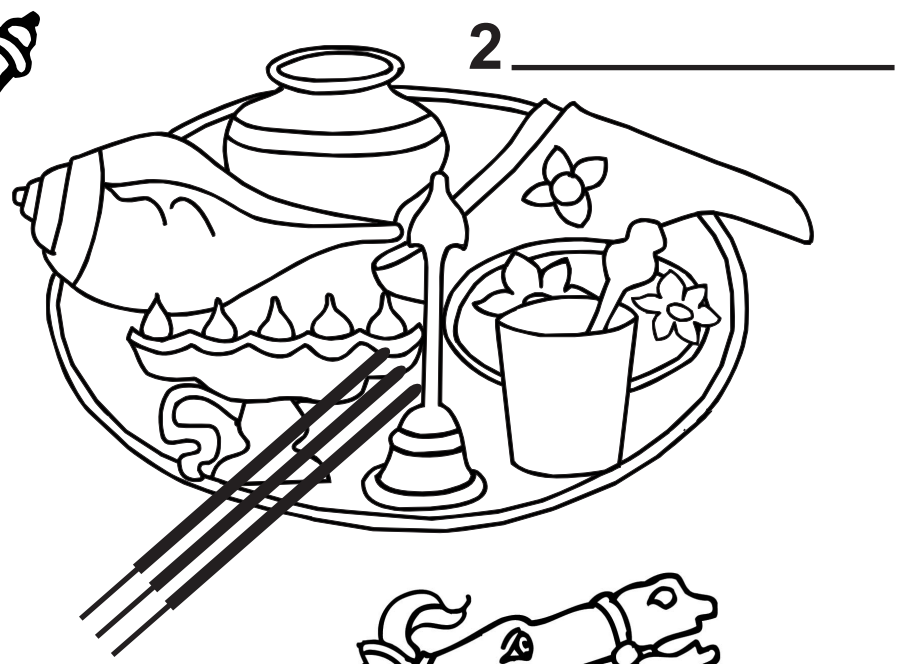
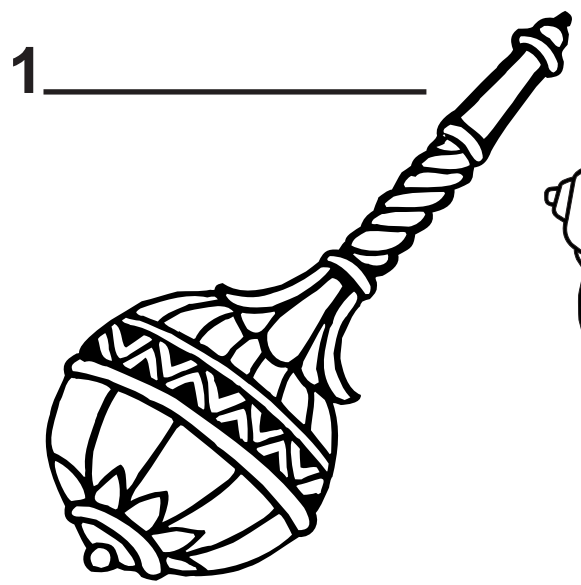

1	2	3	4	5	6	

Write first Alphabet of each No. Picture

Write names of each Picture

1 \_\_\_\_\_

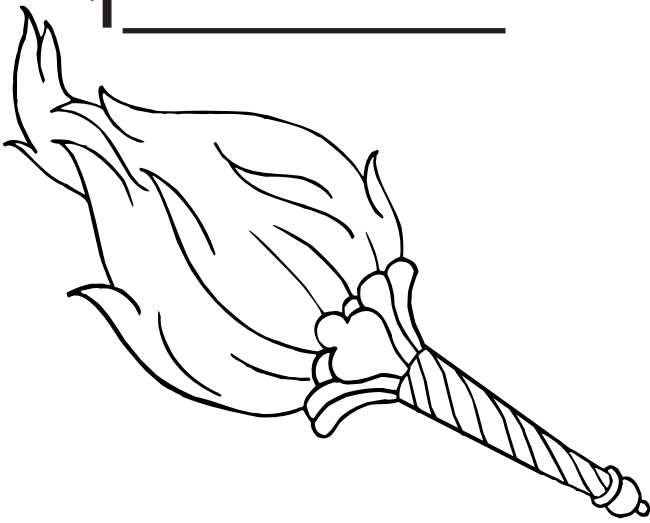

2 \_\_\_\_\_

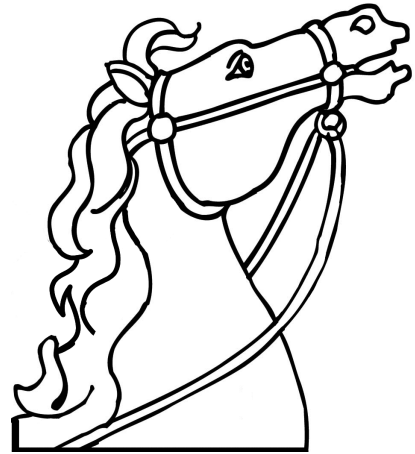

3 \_\_\_\_\_



4 \_\_\_\_\_

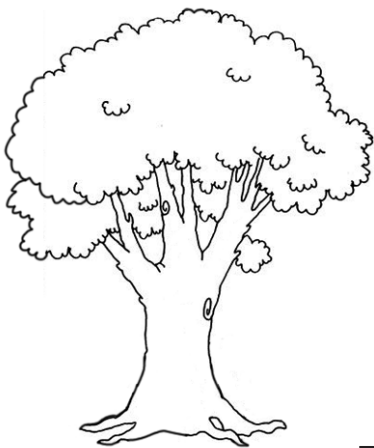

5 \_\_\_\_\_

--	--	--	--	--

1      2      3      4      5

Write first Alphabet of each No. Picture

Write names of each Picture

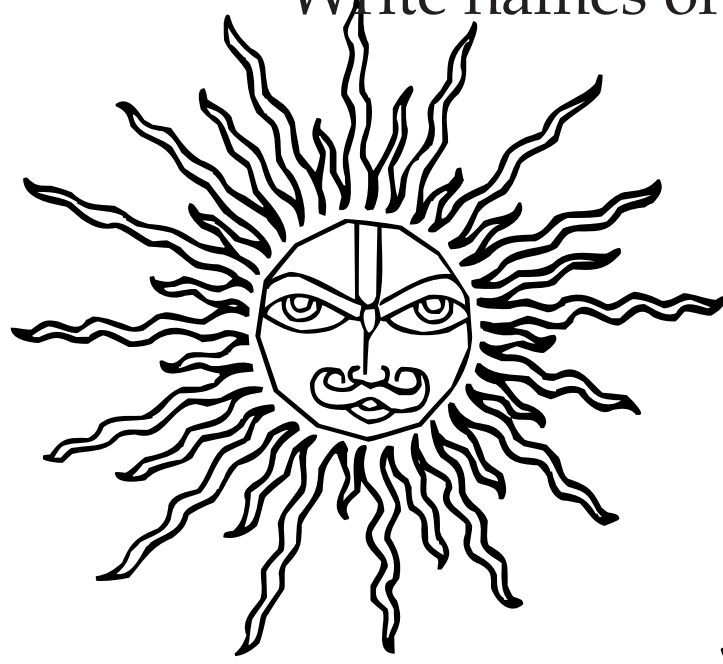

1 \_\_\_\_\_

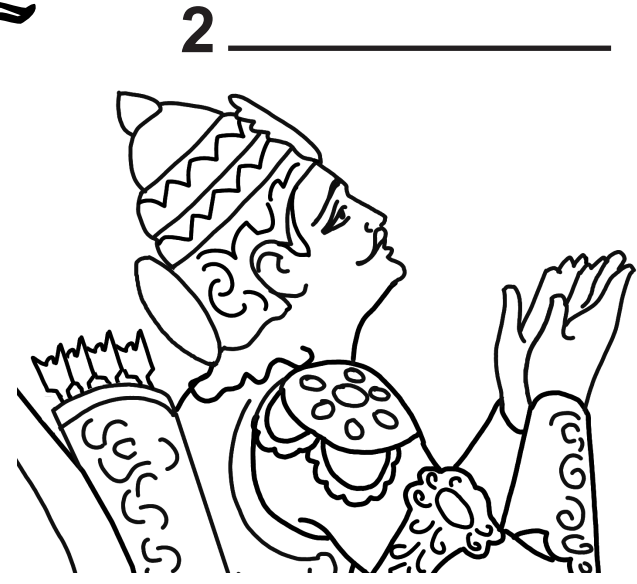

2 \_\_\_\_\_

3 \_\_\_\_\_



4 \_\_\_\_\_



--	--	--	--

1      2      3      4

Write first Alphabet of each No. Picture

# Write names of each Picture

1 \_\_\_\_\_



2 \_\_\_\_\_



3 \_\_\_\_\_



4 \_\_\_\_\_



5 \_\_\_\_\_

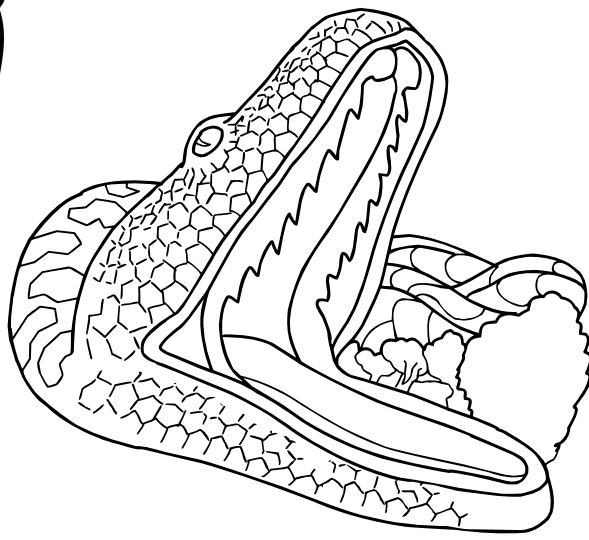

6 \_\_\_\_\_

--	--	--	--	--	--	--

1      2      3      4      5      6

## Write first Alphabet of each No. Picture



# Write names of each Picture

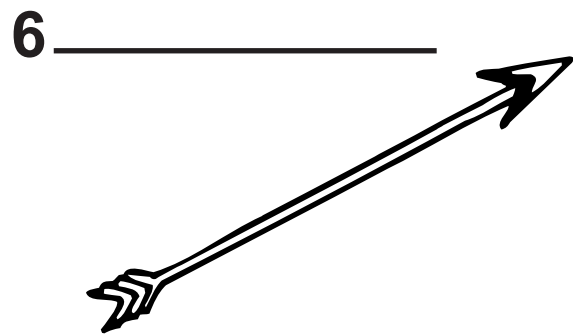
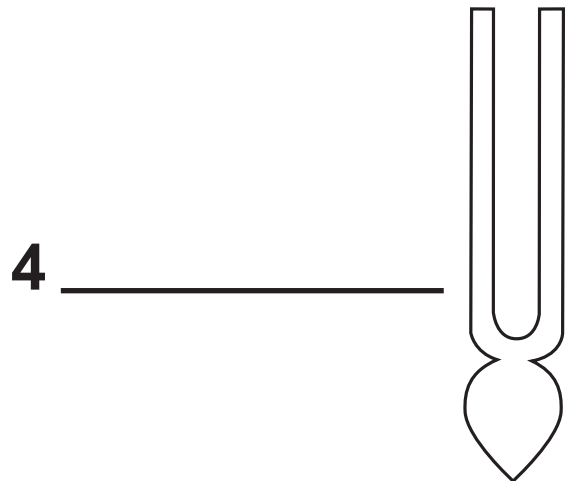
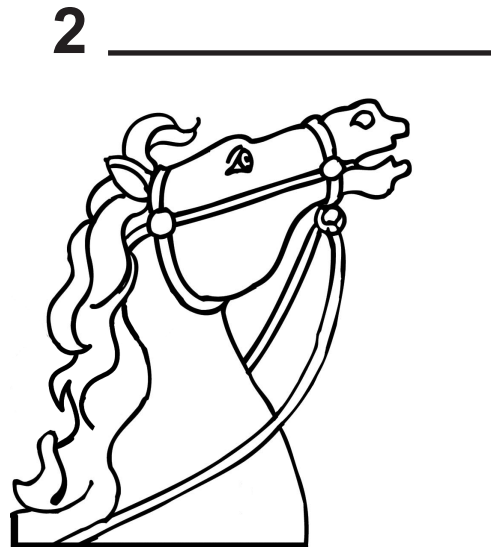

1	2	3	4	5	6	

Write first Alphabet of each No. Picture

Write names of each Picture



1 \_\_\_\_\_

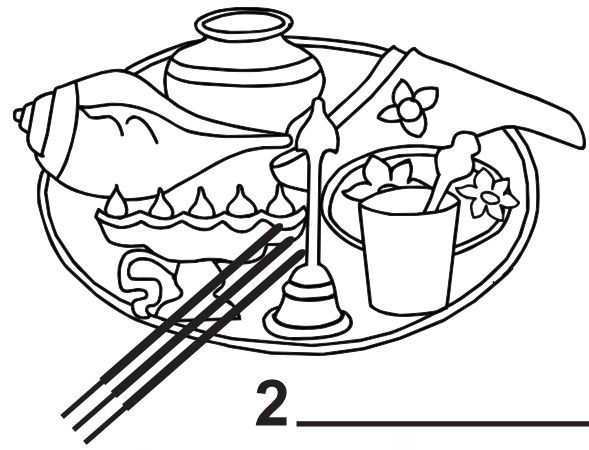

2 \_\_\_\_\_



3 \_\_\_\_\_

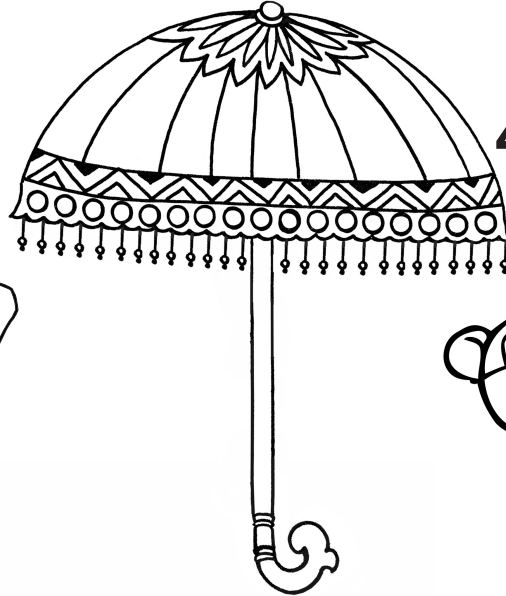

4 \_\_\_\_\_

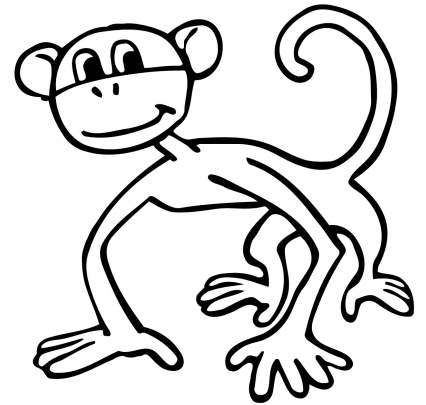

5 \_\_\_\_\_



6 \_\_\_\_\_



7 \_\_\_\_\_

--	--	--	--	--	--	--	--

1      2      3      4      5      6      7

Write first Alphabet of each No. Picture